

Rocla



Maximizing your performance

logistic

Sold & Serviced by
UNICARRIERS.

Content

- » Company Introduction 2 – 3
- » Automated Guided Vehicles 4 – 11
- » Production Solutions 12 – 19
- » Warehouse, Storage and
Distribution Center Solutions ... 20 – 27
- » Paper, Bale and
Reel Handling Solutions 28 – 33
- » Warehouse Management and
Control Systems 34 – 35
- » Navigation and Energy 36 – 37
- » Service 38 – 39
- » Contacts 40

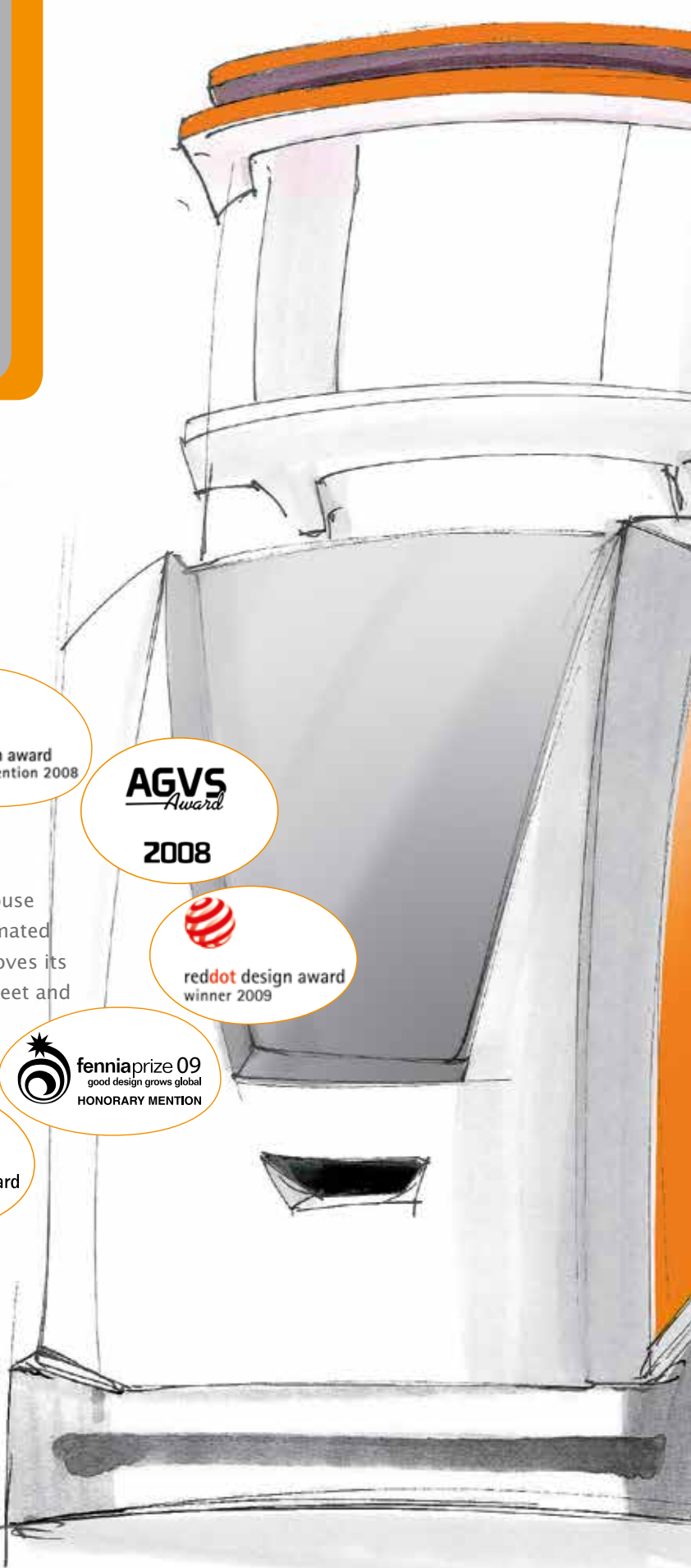

Rocla is a Finland-based global company whose core business is to provide intelligent materials handling solutions and services. Over the 70 years of operation Rocla has evolved from a small family-owned company into world-class warehouse truck manufacturer. With strong warehouse and automated guided vehicles expertise as a foundation Rocla improves its customer's logistics operations with comprehensive fleet and service offering. Continuous innovation, awarded user-friendly design, and customer-driven service form the basis for its operations and products.



*What if you
could reach **YOUR**
12 MONTH TARGET
IN 11 MONTHS*

Don't get us wrong. We don't pretend to know your business better than you do. But we do know intralogistics inside out.

WE ARE NOT OFFERING YOU FIXED SOLUTIONS.

There aren't any. It's about your processes. In logistics, top performance begins with the process. Our industrial design always draws from customer processes, resulting in measurable performance boosts.

The same applies to our services, be they single modules or total solutions. Quite simply:

WE GUARANTEE YOU MORE EFFICIENCY.

- » **Experience in the AGV business since 1983**
- » **Over 1,000 AGV systems, with more than 7,000 vehicles delivered**
- » **One of the largest manufacturers of electrically powered warehouse trucks in Europe**
- » **Since 2009, part of Mitsubishi Logisnext group**

Win **six seconds** for every minute.

That's **one day** for every ten days.

**MAKING
EVERY
SECOND
COUNT**

Automated Guided Vehicles

MODULAR TECHNOLOGY BASED ON WAREHOUSE TRUCK SOLUTIONS



From a standard warehouse truck

Our AGVs (Automated Guided Vehicles) are based on proven warehouse truck technology by Rocla. The vehicles are automatically navigated and operate without drivers. As part of customers' production and intra-logistics, they are used to increase the performance of production and warehousing.

Until now, automation has not provided the answer to this problem, because of expensive, inflexible, and slow implementation. We decided to solve this problem by combining our automation know-how with traditional warehouse trucks. The result is the **world's first serially manufactured Automated Warehouse Truck (AWT)**.



Load handling

According to customer requirements

- Forks
- Roll conveyors
- Paper reel clamps, etc.

Mast

- According to customer requirements
- Rocla's patented Integral mast

Support structure / support legs

- According to customer requirements
- Parameters / pre-designed components

Tractor unit

- Standard model



To a fully modular AGV

- » AC technology
- » Improved driving and lifting speed
- » Considerably greater energy efficiency
- » Maintenance-free components
- » Patented Integral mast

**OUR MOST
COMMON
AGV APPLICATIONS**



**Conveyor pick-up /
drop-off**



Block storage



Racking

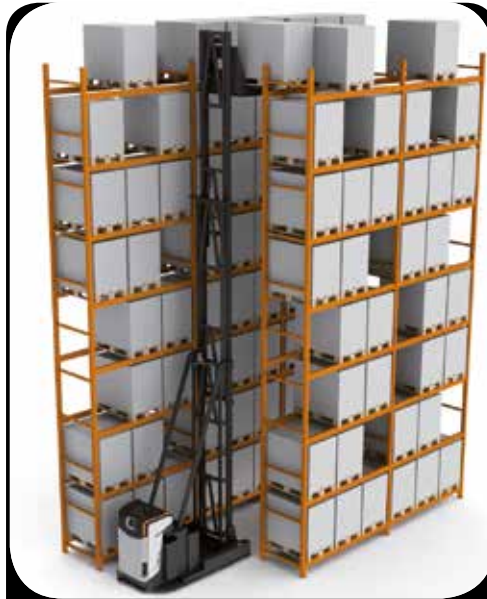

**VNA applications
Up to 417 in. or 34 ft.**



Load-on-load buffer

Different navigation technologies can be chosen



Laser triangulation
(the most common)



Magnetic spots
(for high block storages)

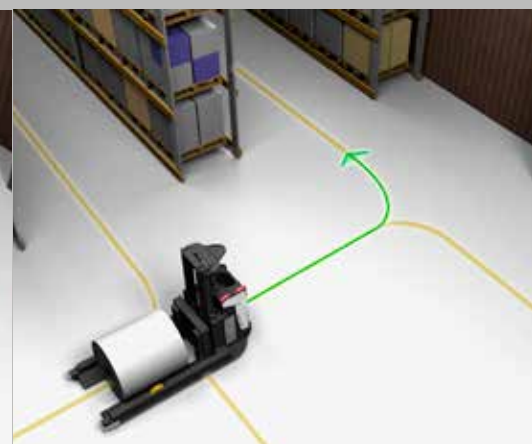

Floor wire
(for special applications)

FOCUS ON CUSTOMERS' LOGISTICS CHALLENGES

Consultation

- Seeking the best possible solutions
- Creative and effective ideas
- Simulation / visualization

AGV Control System

- Order assignment and vehicle allocation
- Supervision of transport tasks
- Traffic control

Warehouse Management System (WMS)

- Transport order generation
- Operator interface
- RFID and barcodes

On-Site Services

- Commissioning
- Installations

Life-Cycle Support

- Service and maintenance
- Updates and upgrades
- Spare parts

Reporting

- Reports on performance, etc.
- Knowledge of what is happening

Vehicles

- Transportation of pallets, reels, etc.
- Navigation: laser, magnetic spot, wire
- Specifications and design

Energy Concept

- Batteries
- Automatic charging
- Battery exchange: automatic / manual

Storage of Goods

- Racks and shelves
- Storage spaces on the floor
- Load-on-load, deep stacking

Additional Machinery

- Conveyors
- Wrapping machines
- Manual trucks
- OEM equipment

You get
a total
logistics
solution



SAFETY AND ENVIRONMENT

All of our installations are built according to the highest safety standards. Our safety solution is tailored to the customer case on the basis of a risk analysis.

All Rocla AGVs have the following safety devices, at minimum:



Consideration for the environment

- ≈ No direct CO2 or other harmful emissions
- ≈ Very low noise level
- ≈ Minimal waste

Positive effects on customers' operations

- ≈ Lower risk of accidents
- ≈ A peaceful and healthier work environment
- ≈ Less sick leaves

Rocla products **are all CE marked**, and our deliveries comply with the Machinery Directive 2006/42/EC as well as other applicable directives.



CUSTOMER BENEFITS

Rocla's advanced technological standard results in the following benefits for the customer:

Implementation

- Short delivery time, typically less than 20 weeks
- Easy implementation even during full production
- Minimum modification to existing buildings
- No additional fixed structures

Operation

- No damages to customers products, buildings or machinery
- Reliable 24/7 operation in critical applications
- Traceable, properly identified product movement
- Dramatically increased safety
- Environment-friendly technology
- Hygienic operations

Maintenance and modifications

- Logistical flexibility - easy updates and modifications
- Low life-cycle cost
- Reduced operation and maintenance costs:
 - ◊ Local maintenance through the Rocla service network
 - ◊ 24/7 global help desk



FINANCIAL ADVANTAGES

We performed a long term study of the financial effects on our customers' operations in comparison to traditional forklift solutions in Western Europe within the following sectors:

- Warehousing and storage
- Paper, printing and packaging
- Production

Most of the savings are achieved through the following factors:

- Reduced damages to the transported goods and buildings (in some sectors, such as the paper industry, up to 1-2 % of the annual production)
- Lower labor costs

As an overall average outcome it can be stated, 4-5 automated vehicles replace 3 traditional forklifts. The graph shows the cash flow based on this example in 2 and 3 shifts.

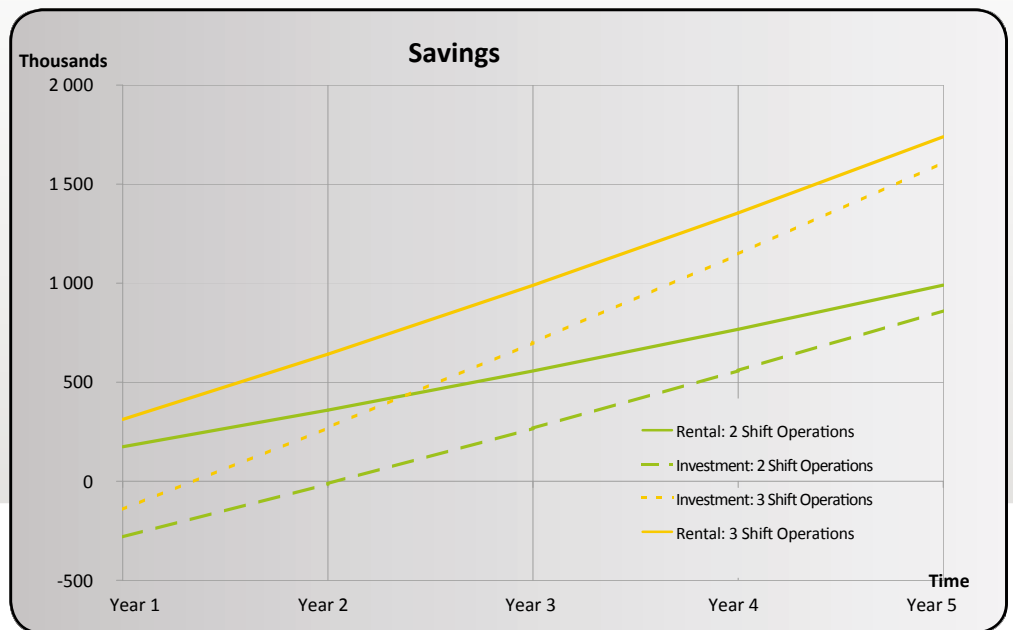

› Rocla's Financing Options

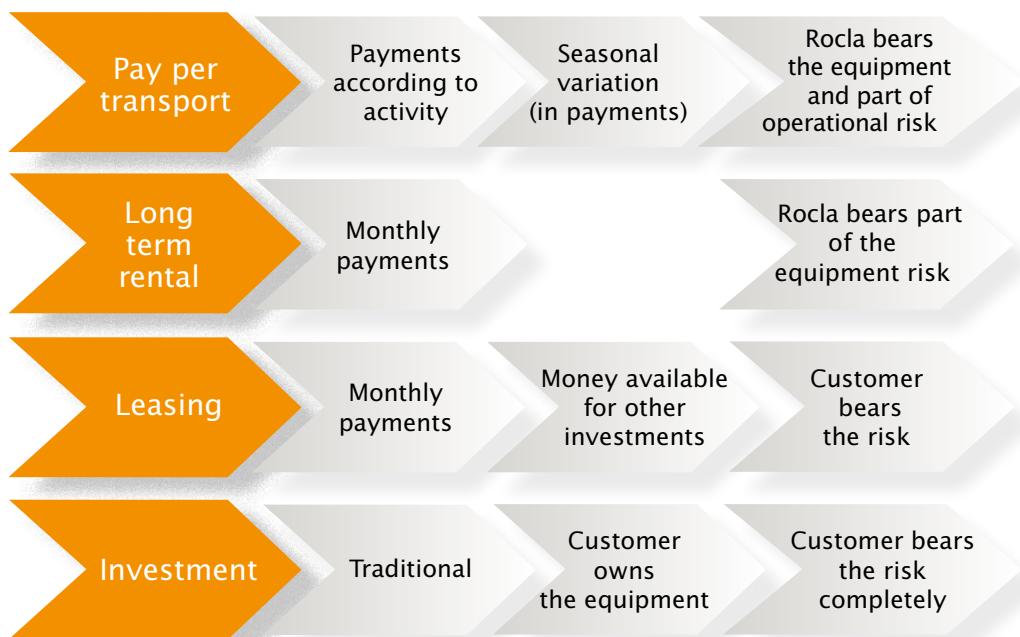

Automated Guided Vehicles

VEHICLE SELECTION CHART

available
 limitations apply, check with your contact

Fork Vehicles

	Fork Over	Fork Over with Lift	Straddle	Counterbalance	Reach Mast	Very Narrow Aisle with Tri-Lateral Head
Deep Stacking	<input checked="" type="radio"/>	<input checked="" type="radio"/>	<input checked="" type="radio"/>	<input checked="" type="radio"/>	<input checked="" type="radio"/>	<input checked="" type="radio"/>
Load-on-Load	<input checked="" type="radio"/>	<input type="radio"/>	<input checked="" type="radio"/>	<input checked="" type="radio"/>	<input checked="" type="radio"/>	<input checked="" type="radio"/>
Block Storage	<input checked="" type="radio"/>	<input type="radio"/>	<input checked="" type="radio"/>	<input checked="" type="radio"/>	<input checked="" type="radio"/>	<input checked="" type="radio"/>
Racks	<input checked="" type="radio"/>	<input type="radio"/>	<input type="radio"/>	<input checked="" type="radio"/>	<input checked="" type="radio"/>	<input checked="" type="radio"/>
Conveyor	<input type="radio"/>	<input checked="" type="radio"/>	<input checked="" type="radio"/>	<input checked="" type="radio"/>	<input checked="" type="radio"/>	<input checked="" type="radio"/>
Floor Operations	<input checked="" type="radio"/>	<input checked="" type="radio"/>	<input checked="" type="radio"/>	<input checked="" type="radio"/>	<input checked="" type="radio"/>	<input checked="" type="radio"/>
Drive-In Racks	<input type="radio"/>	<input type="radio"/>	<input checked="" type="radio"/>	<input checked="" type="radio"/>	<input type="radio"/>	<input checked="" type="radio"/>
Gravity Flow Rack	<input checked="" type="radio"/>	<input type="radio"/>	<input type="radio"/>	<input checked="" type="radio"/>	<input checked="" type="radio"/>	<input checked="" type="radio"/>
Push-Back Rack	<input checked="" type="radio"/>	<input type="radio"/>	<input type="radio"/>	<input checked="" type="radio"/>	<input type="radio"/>	<input checked="" type="radio"/>
Warehouse	<input checked="" type="radio"/>	<input checked="" type="radio"/>	<input checked="" type="radio"/>	<input checked="" type="radio"/>	<input checked="" type="radio"/>	<input checked="" type="radio"/>
Production	<input checked="" type="radio"/>	<input checked="" type="radio"/>	<input checked="" type="radio"/>	<input checked="" type="radio"/>	<input checked="" type="radio"/>	<input checked="" type="radio"/>
Shipping Area	<input checked="" type="radio"/>	<input checked="" type="radio"/>	<input checked="" type="radio"/>	<input checked="" type="radio"/>	<input checked="" type="radio"/>	<input type="radio"/>
Automatic Order Picking	<input type="radio"/>	<input checked="" type="radio"/>	<input type="radio"/>	<input type="radio"/>	<input checked="" type="radio"/>	<input checked="" type="radio"/>
Reel Storage	<input checked="" type="radio"/>	<input checked="" type="radio"/>	<input checked="" type="radio"/>	<input checked="" type="radio"/>	<input checked="" type="radio"/>	<input checked="" type="radio"/>

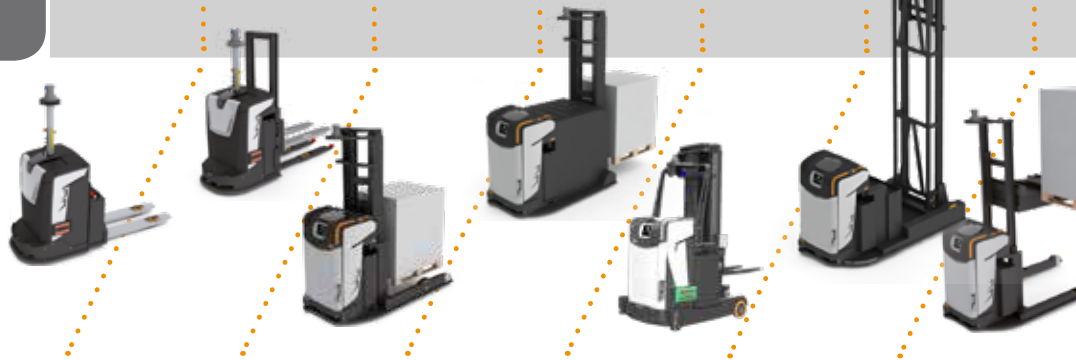

Reel & Clamp Vehicles

Other Vehicles

Very Narrow Aisle
with
Telescopic Forks

Reel Forks

Reel Clamp

Heavy Rotating
and Tilting Clamp

Box Clamp

Conveyor

Lift Conveyor

Deep Stacking

Load-on-Load

Block Storage

Racks

Conveyor

Floor Operations

Drive-In Racks

Gravity Flow Rack

Push-Back Rack

Warehouse

Production

Shipping Area

Automatic Order Picking

Reel Storage



Production Solutions

Do you dream of
HIGHER SAFETY?

In the past, a lot of attention was paid to tuning the production, while production logistics received less attention. Today it is essential to tune the material flow also. Our solutions reduce the cost of holding while also protecting and controlling the materials.



The following pages present some ideas for improving the material handling in the manufacturing area.

- Work-in-progress storage
- Quarantine area
- Transport within the process
- Automatic picking
- Trash bin handling
- Link to the warehouse

- » **Just-in-time**
- » **No interruptions in production**
- » **Constant and reliable operations**
- » **Releases workers for more productive tasks**

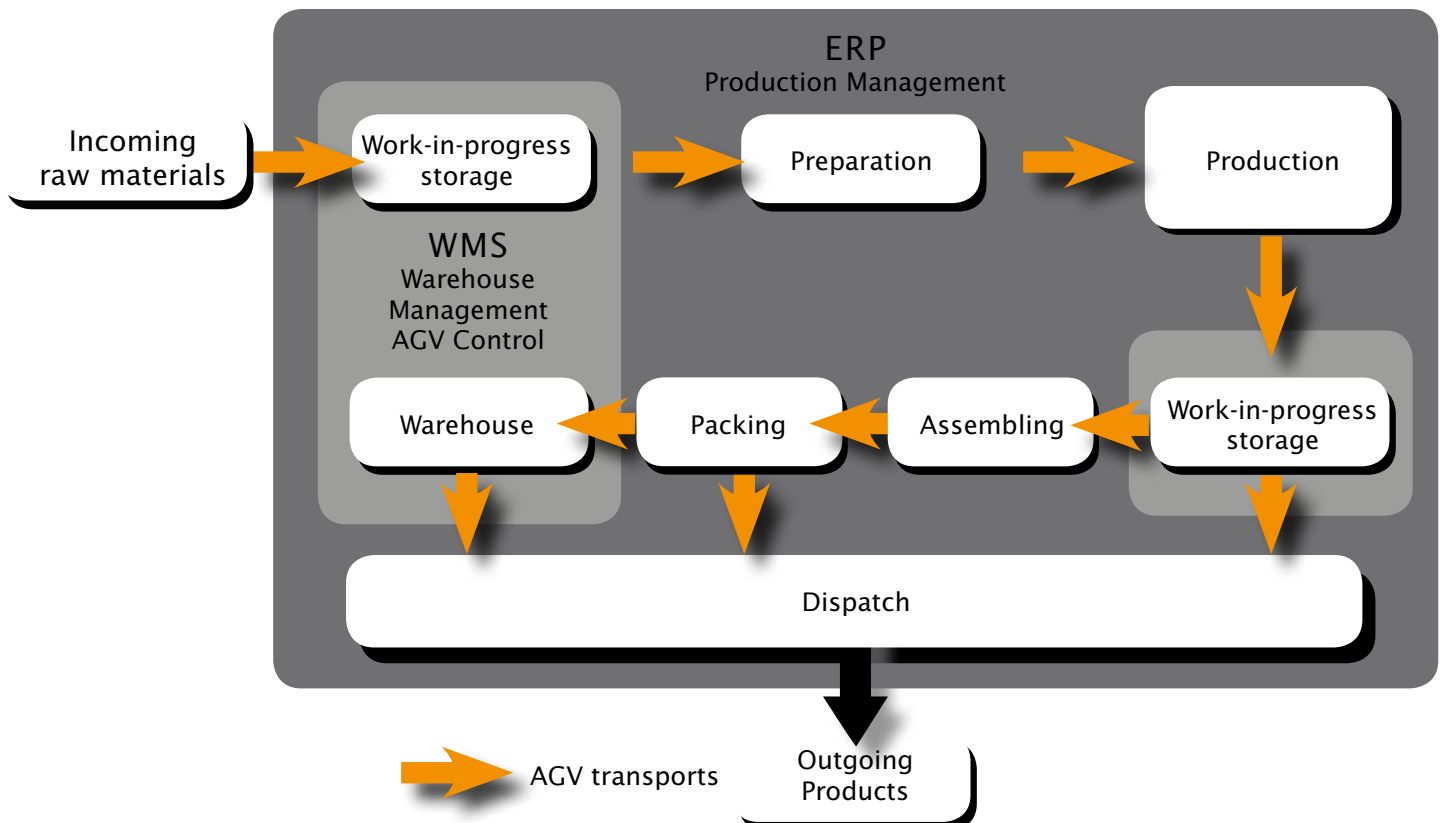

Seeberger

Seeberger GmbH, Germany's leading producer of dried fruit and nuts, uses Rocla's AGVs at its production plant in Ulm. Return on an investment in an automated transport solution was an attractive solution for Seeberger due to the high transport volumes with which it works. Accurately synchronised infeeding of raw materials to the packing machines and as little as possible intervention in the existing infrastructure were significant prerequisites for the company. The AGV stood out as the best solution in this regard. Five Rocla Automated Guided Vehicles (AGV) transport the raw materials from the warehouse to the Seeberger GmbH production facility.

The fruit and nut pallets are relatively lightweight, and this is why Seeberger chose the ATX12 model. It is an AGV designed specifically for pallet transport, capable of lifting loads of up to 1250 kg to a height of 1800 mm. The structure of this vehicle is modular and particularly compact, making it especially suitable for use in areas with limited space.

Project manager Marc Eberhardt is pleased with Rocla's automated guided vehicle (AGV) system. He stresses the reliability and efficiency of the system. "The AGV and our automatic high bay storage facility are controlled by our production management system (PMS). This allows optimum interaction of our various systems. We achieve maximum utilisation of the AGV systems transport capacity thanks to minimal waiting times at the warehouse and accurately synchronised delivery of the raw materials to the packing machines", explains Mr. Eberhardt.

Admittedly, the staff were reluctant to work with the new driverless transport vehicles initially. However, they soon abandoned their reservations when it became clear how reliably, safely and efficiently the AGV works. Since the system was deployed, there have been no accidents or any damage to property.

The Seeberger production plant has a ramp sloping at an angle of 9%. One of the project objectives was to integrate this ramp into the vehicle routes without adversely impacting on the overall performance of the AGV. To do this, additional safety measures had to be implemented in order to ensure redundant detection of the ramp and also limit the speed in this area.

Project info:

Produces dried fruits and nuts.
Automated the raw material transport from the warehouse to production facility.



"The high level of automation ensures that the right goods are in the right place at the right time and in the right quantities. Moreover, we maintain a constant accurate overview of our current flow of goods and stock levels." Marc Eberhardt, Project Manager, Seeberger

› Work-In-Progress Storage

Put simply, WIP storage is used inside the production process to store the unfinished goods until the next step in production. The goods can be on standard pallets, in cages, on a special loading platform or some other platform. WIP storage is operated automatically according to process needs. It can be FIFO, LIFO, or something else that supports the operations. The system tracks the goods and the stage of production, thus reducing the value in inventory and increasing the effectiveness of production by delivering the correct goods when needed.

- Automatic operations
- Tracking of the goods and stage of production
- FIFO and LIFO operations
- Just-in-time
- Possibility to locate further away from production, where more space is available

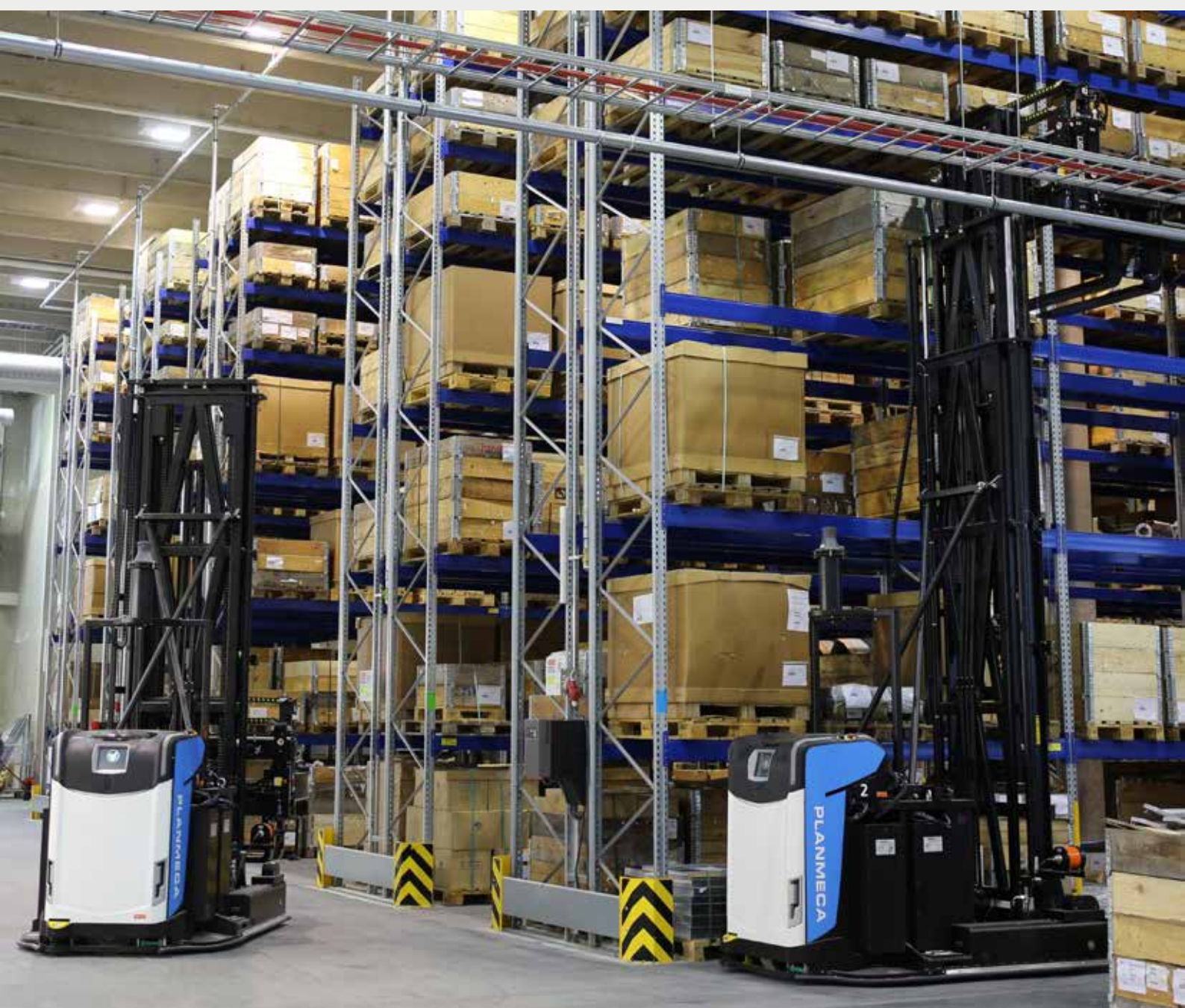

› Quarantine area

In some processes, it is essential to ensure that the products are in quarantine long enough. The reasons might be drying, maturing, or quarantining of the goods. This functionality is achieved automatically with our solution, eliminating the room for human error which can be critical in some operations.

How
CRITICAL
is your
PRODUCTION?

› AWT Counterbalance

Options for two- or four-pallet transport.

- » **Lifting height up to 22 ft**
- » **Loads up to 4,409 lbs.**
- » **Compatibility with drive-in racking**
- » **For push-back racks**
- » **For gravity racks/free flow racks**
- » **Ideal solution for applications where support legs cannot be used**

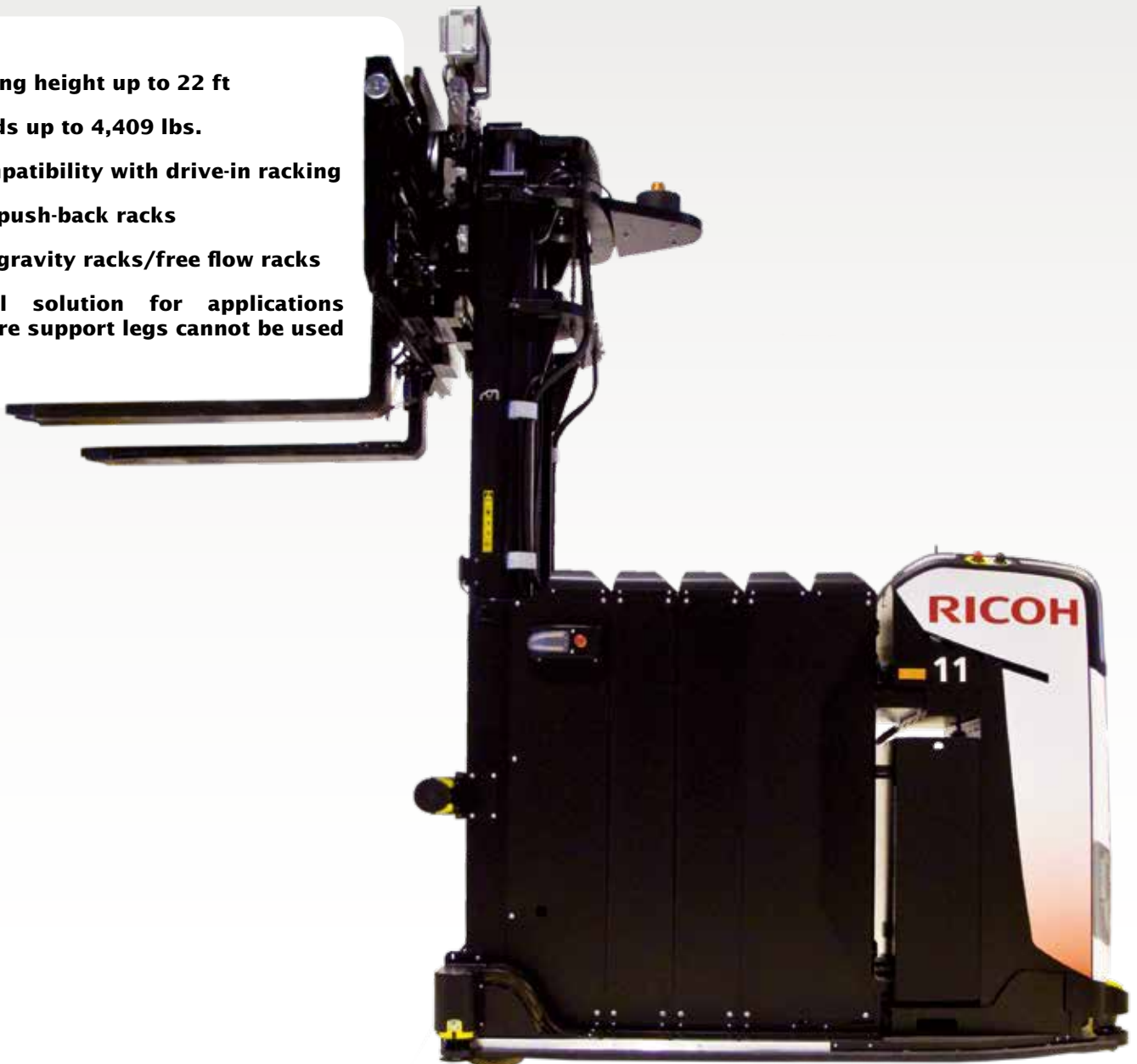

Production Solutions



› AWT Straddle

The most common AWT is the straddle series. It works well in different applications and has an appealing price/performance balance.



Load-on-load and deep stacking of pallets



- › **Lifting height up to 338 in.**
- › **Loads up to 11,023 lbs.**

› ATX12

This series is designed for those operations now performed mainly with low-level order pickers or stackers.



ATX deep stacking pallets

- › **For horizontal load movement**
- › **Lifting height up to 59 in.**
- › **Loads up to 2,645 lbs.**

ATX12



› Conveyor extension

The Rocla conveyor AGV is great for expanding the functionality of conveyor systems. It works as an unfixed conveyor that is able to pick-up and deliver several conveyors. This allows the area to remain open for people and forklift traffic. Another factor is that conveyor system failure suspends all movement of material in the process. With the AGV system, the material keeps moving even if one vehicle is non-operational. The AGV system also leaves the floor space open for easy cleaning and maintenance.

- Unfixed
- Conveyor extension
- Fail-safe operation
- Flexible
- Intersecting/crossing of human and forklift traffic possible
- Vertical conveyor functionality as option



- trash and recycle bin automatic handling
- operation in idle time

› Trash bin handling

It is common to use an AGV to handle also trash bins at the site. During idle time, the truck can replace the trash / recycling bins with empty ones. Alternatively, the vehicle can empty the bins automatically, reducing the need for operator actions.



› **AWT Conveyor**

- › **For 1-4 conveyors**
- › **Fast operation**
- › **Loads up to 11,023 lbs.**
- › **Lift function as an option**

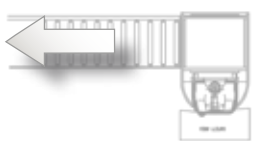
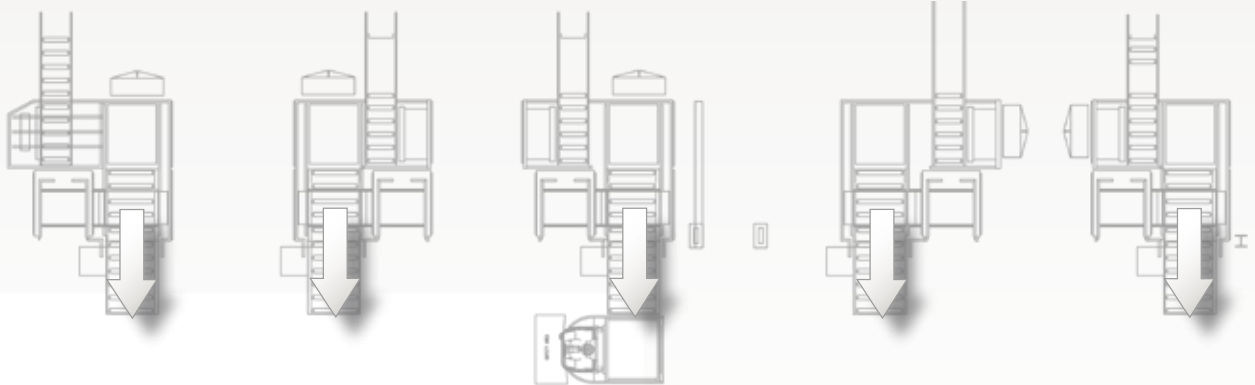

Warehouse, Storage and Distribution Center

Are you
ready for
**PERFORMANCE
BOOST?**

Logistics is one of the biggest cost factors in the industry. The task is to improve material handling efficiency and therefore reduce costs and increase profitability. It is possible to implement Rocla solution to your existing operations as well as green field projects. This is where Rocla can be the ideal partner for additional benefits.

On the following pages are ideas for warehouse, storage and distribution center operations. The correct vehicle type is selected on the basis of the needs and specifications of process in question.

- Improve material handling efficiency
- Reduce costs and risk
- Increase storage efficiency
- Compatibility with existing operations



Bring Logistics



Project info:
Leading 3PL provider
in the Nordics.
Automated pallet
handling in a very
narrow aisle
logistic center.

Bring Logistics, a leading third-party logistics provider in the Nordic region, uses Rocla's automation solution in their warehouse in Berger, near Oslo. Nine Rocla VNA AGVs handle the pallets in the very narrow-aisled racking area.

The 32,000-square-metre, highly automated Skedsmo Logistic Center opened in the spring of 2010. Nine Rocla VNA units, automated guided vehicles designed for facilities with narrow aisles, handle the pallets in the very narrow-aisled racking area. Automating such processes in the warehouse increases safety and reduces the operation costs.

The racking area where the vehicles operate contains, in total, 81,200 pallet places, extending to a height of 419 in. The automated trucks pick up and leave their loads at a conveyor when transporting pallets into and out of the racking area. The transport capacity is 173 pallets an hour, with a maximum lifting capacity of 2,204.62 lbs. per pallet.

Using Rocla AGVs in VNA warehouses minimises the risk of incorrect load handling. These AGVs handle the loads in the same way every time, and the risk of pallets falling is very low. Automation also reduces the need for personnel working in the same area, which limits the risk of a serious incident. The temperature in the Bring Logistics racking area is lower and there is less light than in a traditional warehouse with human-operated VNA trucks, factors that reduce energy consumption.

Rocla's automated guided vehicles use multi-method navigation in the Bring Logistics warehouse: laser navigation in the master aisle and inductive wire navigation in the narrow aisles. The AGVs are equipped with triplex masts and sideways telescopic forks as used in Rocla's manual narrow-aisle truck. Thanks to Rocla's modular design and use of standard components, the delivery time was shorter than in traditional automation projects. The time to return on investment in three-shift operation is less than two years.



*"Automating pallet handling was a more cost-efficient solution than using a manual solution. We chose Rocla because Rocla was able to offer a proven technology concept to fit our demands related to safety and function."
Geir Nielsen, Logistics Director,
Bring Logistics*

› ART Automated Reach Truck

Rocla's automated reach truck is designed to operate in an aisle width of 9.8 feet. New and innovative software and sensor technology increase the load handling speed considerably. The agile turning radius and lifting capability of 32 feet fulfill the requirements of the most common warehouse environments.

- Distribution centers
- Warehouses
- Work-in-progress storage
- Replenishment of active picking locations



- » **Lifting height up to 393 in.**
- » **Loads up to 3,527 lbs.**
- » **118 in. aisle width**
- » **Increased load handling speed**
- » **Improved safety features**
- » **Compatibility with existing warehouses operated by manual reach trucks**

AUTOMATIC PALLET WAREHOUSE



Safety first

- Three scanners provide safe operation according to safety standards for AGVs.
- The unique safety installation creates a dynamic field in the moving direction, which allows faster turning of the vehicle.
- A dynamic stability control system constantly monitors speed, load weight and height as well as reach position.

Precise load handling

- A pressure compensation system provides an efficient and constant lifting regardless of the load weight.
- During load handling a collision detection ensures the safety of this operation.



› AWT Counterbalance

Options for two- or four-pallet transport.

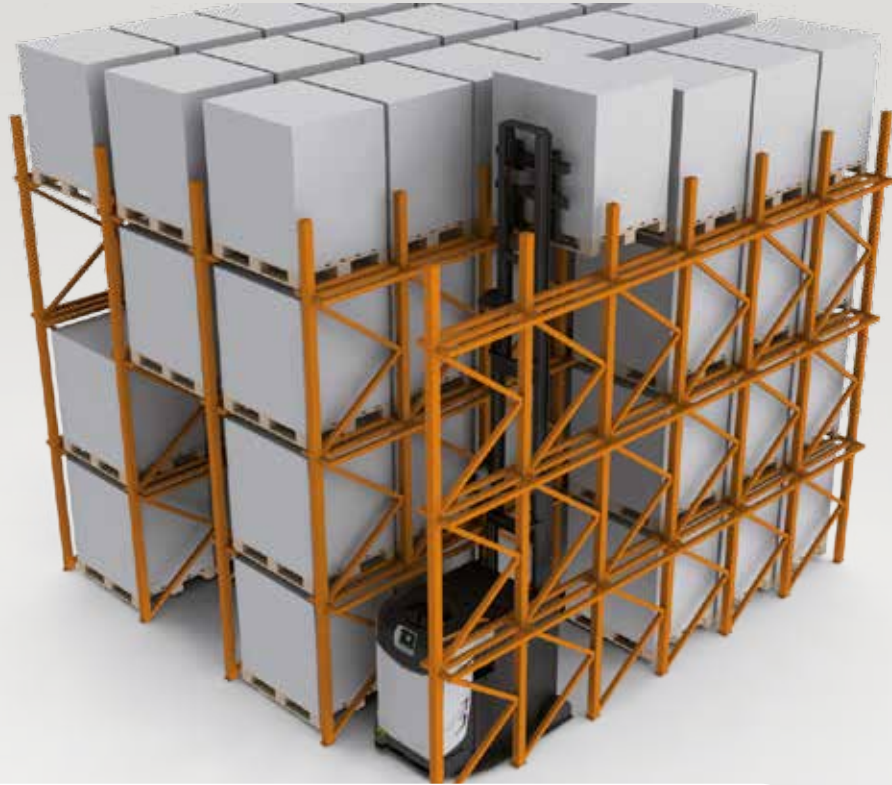

- » **Lifting height up to 275 in.**
- » **Loads up to 4,409 lbs.**
- » **Compatibility with drive-in racking**
- » **For push-back racks**
- » **For gravity racks/free flow racks**
- » **Ideal solution for applications where support legs cannot be used**

AUTOMATIC ORDER PICKING & REPLENISHMENT

› Automatic Order Picking

The order picking process is a very essential part of companies' operations. It can be highly effective or a bottle neck. Therefore, we have invested in developing means to improve the efficiency of the picking process. In automatic picking, the orders, either in boxes or on pallets, are picked with the aid of automatic trucks. Full pallets are picked completely automatically, without an operator. Boxes are picked by the operator from the picking area for the near-by automatic truck. The picking list can be on a computer, or audio-picking can be used.

- Ensure the company's competitive edge
- Decrease the time spent per picking row
- For box or pallet picking
- Integration with existing operations

› Automatic Replenishment

Automatic replenishment supports the picking process by automatically filling the active picking locations from reserve. This virtually eliminates the need to wait for replenishment and thus increases productivity. The system also fills the reserve locations automatically by picking the pallets from the area for incoming materials. In addition, the system can be used also for automatic pallet picking and delivery to the shipping area.

- Replenishment of active picking locations
- Filling of the reserve locations
- Full pallet picking



› ATX

This series is designed for operations performed today with manual pallet movers or low-level order pickers. There are versions for single- and double-pallet moving from floor to floor.

- Distribution centers
- Semi-automatic order picking
- Moving of pallets to the shipping area
- For long pallet moving needs



- » **For order picking**
- » **For floor to floor operations**
- » **For one- or two-pallet handling**
- » **2,755 lbs. lifting up to 66 in.**

› Rocla High Density Warehouse

Rocla's High Density Warehouse maximizes the storage capacity in a given volume of space or minimizes the space needed to achieve the agreed warehouse capacity. The solution is good for highly valued land areas, since it minimizes the required squares. This is achieved by utilizing the heavy moving racks in combination with Rocla's other solutions.

- Direct access to all pallets
- Reduce operational costs
- An extremely safe system
- Easy expansion of storage capacity
- Easy expansion of throughput (pallets in/out per hour)
- Integration with existing operations

Solutions

› AWT Narrow Aisle

The AWT narrow aisle series is intended for pallet handling and storage applications in pallet racking with very narrow aisles (VNA). The vehicle is specially designed for good performance with high lifts.

This AGV is equipped with telescopic load handling forks as standard. A turret head for trilateral turning (90°...0°...+90°) of load forks is available as an option for more versatile pallet handling.

- Distribution centers
- Warehouses
- Work-in-progress storage
- Replenishment of active picking locations
- Applications requiring high storage capacity per square meter

AUTOMATIC PALLET WAREHOUSE



- » **Lifting height up to 472 in.**
- » **Loads up to 2,645 lbs.**
- » **Save floor space**
- » **Increase storage capacity per square meter**
- » **Very narrow aisle, starting from 68 in.**
- » **Dual navigation**
- » **Compatibility with existing warehouses**

Paper, Bale and Reel Handling Solutions

Would you like to **SAVE MONEY AND TIME** with **ONE PARTNER?**

In recent years, we have successfully completed an increasing number of projects in the paper, print, packaging, and tissue industry. The intention is to automate production and storage processes and to replace conventional material handling equipment.

Rocla's modern solutions offer a wide range of reliable and efficient applications.

- News print day storage
- The commercial printing industry
- The packaging industry
- The paper industry
- The tissue industry
- The aluminium industry



- » **Driverless transportation**
- » **Improved safety on the work floor**
- » **No damages to products, buildings, or machinery**
- » **Traceability of products**



Pulp bale storage



Dispatch area



Infeed of converting

Reel storage



Portucel Soporcel

Portugal's leading paper and pulp producer, Portucel Soporcel Group, bought an automated warehouse truck solution from Rocla in 2008. The deal is part of the company's new paper mill in Setúbal.

This installation covers around 20 vehicles for

- transporting reels from intermediate storage to sheet cutting
- transporting pallets from sheet cutting to wrapping

The system also includes an automated battery exchange station (BES) and will be extended with 12 additional vehicles for the intermediate storage.

From deal to delivery

The vehicles were shipped to the new paper mill in May-June 2009. During the summer, the reel logistics in the new converting plant were commissioned and interfaces with the mill's control systems and various machine lines were established as planned.

As production at the new paper mill started, fully automated reel logistics using the latest generation of Rocla AWTs and our automated battery exchange system were also ready to automate production in the converting area.



Project info:
One of the world's largest paper mills for the production of high-quality office and printing papers. Fully automated paper reel and pallet transportation and storage with 20 Rocla AGV vehicles and automated battery exchange station.



*"After evaluating many AGV suppliers, we chose Rocla because of their advanced technological solution and the best total package," explains **Project Area Manager Mr. Carlos Lopes.***

Paper, Bale and Reel Handling Solutions

HORIZONTAL REEL TRANSPORT

› AWT Reel



- » **Lifting height up to 283 in.**
- » **Loads up to 13,227 lbs.**
- » **Adjustable forks for different diameters**
- » **Pick-up from slitters**
- » **Infeed to converting lines**
- » **Operation of rack storages**
- » **Pick-up from reel preparation**
- » **Infeed of printing machines**
- » **Adapter handling**
- » **Trash bin handling**
- » **Aluminium rolls' handling ($\geq 3\mu\text{m}$)**



› **AWT Clamp**

**AUTOMATIC REEL
STORAGE**

- » **Lifting height up to 283 in.**
- » **Loads up to 7,716 lbs.**
- » **Rotating clamps**



Paper, Bale and Reel Handling Solutions

HEAVY LOAD HANDLING

› AWT Heavy Load

- » Lifting height up to 283 in.
- » Loads up to 17,636 lbs.
- » Tilt and rotating clamps
- » Pick-up from conveyors
- » Infeed of converting lines
- » Operation of reel storages
- » Pick-up of rest reels
- » Weight measurement

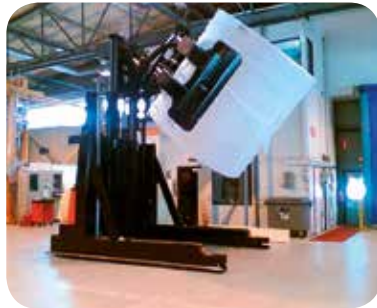
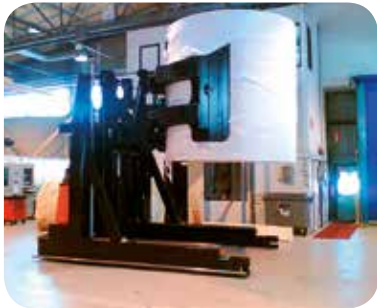

› **AWT Conveyor**



- › **Lifting height up to 39 in.**
- › **Loads up to 2 x 5,511 lbs.**

PAPER SHEET HANDLING



› **AWT Straddle with Load Support**

- › **Lifting height up to 39 in.**
- › **Loads up to 2 x 5,511 lbs.**
- › **Pick-up from conveyors**
- › **Outfeed of converting lines**
- › **Lifting with sisal lifts to multiple heights**
- › **Load support for paper sheets to counterhold the first sheets**

PULP BALE HANDLING

› **AWT Pulp Clamp**

- › **Lifting height up to 283 in.**
- › **Loads up to 3,306 lbs.**
- › **From truck unloading to pulp storage**
- › **Operation of pulp storage**
- › **Transport to de-wiring stations**
- › **Preparation of truck loading**



› Warehouse Management System

Rocla WMS is a software product for management of goods and material flow in warehouses and manufacturing. This product is part of Rocla's range of logistics solutions, with automated guided vehicles and warehouse trucks as key elements for material movement. The focus of the application is on automated material handling systems for paper reels and various palletized goods.

The objective of the Rocla WMS is efficiency in the customer's intralogistics operations as evaluated from the perspective of several customer interest groups, such as floor-level users, the management, company shareholders, and end customers. The outcome is concrete and economical benefits for customers.

For any planned WMS, the feasibility of the objectives is a check-list item and prime decision point, especially in the case of a new facility. We can aid in the early evaluation stage by providing data for a feasibility study and in arranging reference visits. Feasibility is always evaluated for a complete system in a customer application, not for the isolated WMS product.

› Articulated storage and transport control - efficiency

- › Minimize the total amount of AGV driving
- › Avoid AGV traffic congestion and AGVs blocking each other
- › Achieve a high storage filling rate with minimal drawbacks, when needed
- › Organize storage dynamically
- › Gain flexible layout and use of space

› Material inventory management

- › First-in, first-out and first-in, last-out support
- › Age control
- › One-way mode
- › Reservation
- › Locking
- › Process allocation

› Serving of processes

- › Consumer - producer approach to registering moves
- › Single loads, batch and continuous "recipe" or BOM loading
- › Chained processes, following the flow of multi-step manufacturing
- › Logs for material use and creation



› Control System

The control system is an essential part of the automated guided vehicle system, with the main task being to control the AGVs' traffic flow. The system manages transport orders, which involve:

- › order queuing
- › assignment of each order to a suitable AGV
- › monitoring of order progress
- › constantly updated order status

The control system further manages AGV traffic:

- › route selection with intelligent optimizer
- › prevention of blocking
- › AGV traffic is dead lock free



Several transport orders can be given simultaneously to the control system and are placed in the work queue. The work queue is emptied primarily in first-in, first-out (FIFO) order; however, different priority can be given to orders, depending on, for instance, the load station or the production situation. The WMS can reschedule specific orders and also reassign the drop-off location of a current or scheduled transport task.

The control system keeps the free AGVs waiting for a transport assignment from home positions with strategic locations in the facility layout. These AGV home positions can be anywhere in the layout but should be close to the main source stations of material flow, to minimize delay. Also, the home position is normally used for AGV battery charging.

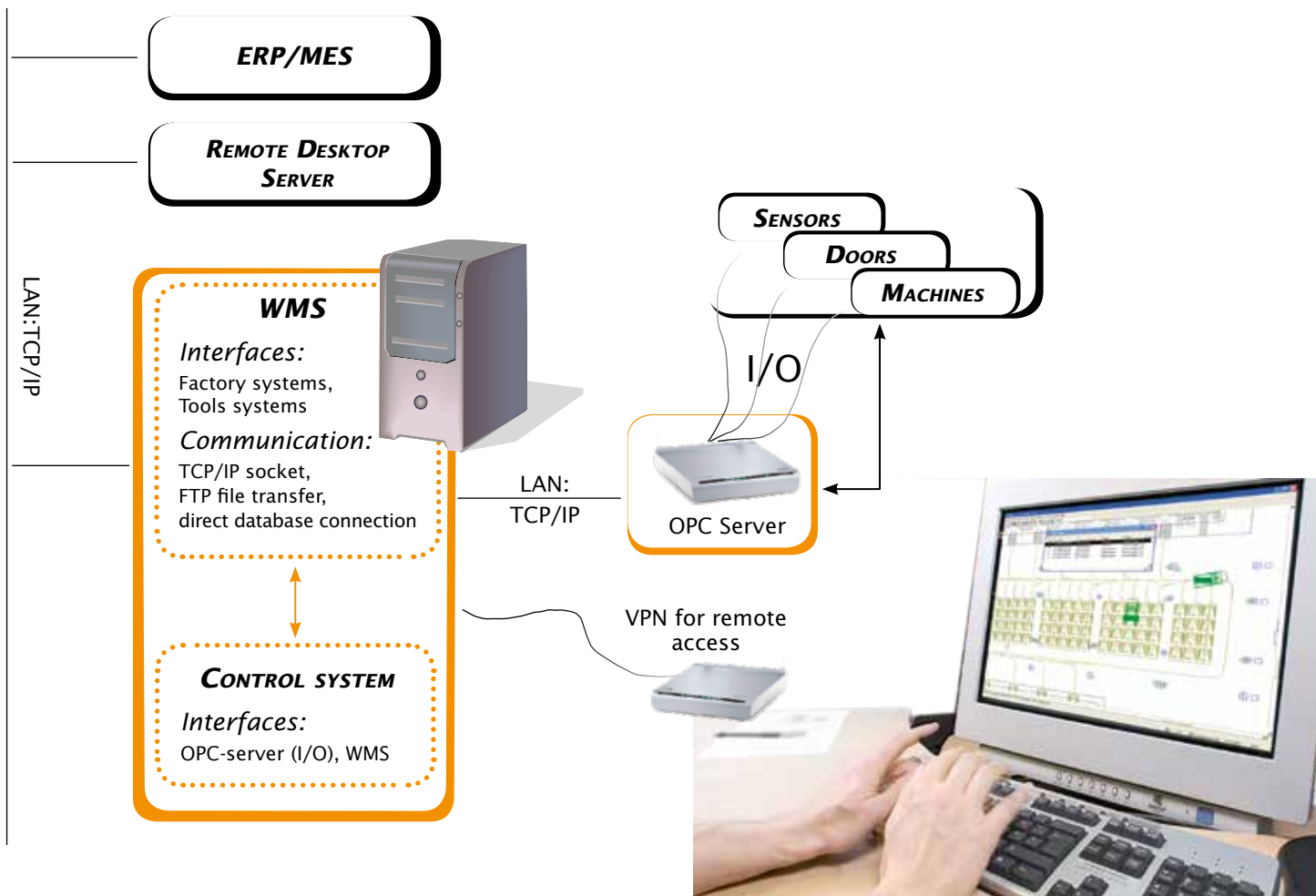

NAVIGATION

An essential part of the logistic solution is the navigation method. This navigation refers to how the trucks move around the facility / premises and know their exact location at all times. This information is used to optimize the performance of the truck fleet and to guarantee the system's safety.

There is an optimal method for different environments. All the methods have their own advantages.

Laser Navigation

is the most common navigation method in Rocla AGV systems.

The navigation is based on reflectors scanned by a laser scanner and the use of trigonometry. The advantages of laser navigation are:

- » Rapid startup of the project
- » The highest vehicle driving speeds
- » The greatest flexibility
- » Reliability
- » Easy and quick updating of the driving routes and load handling stations with software
- » No fixed installations or cutting of the floor

Spot Navigation

is the most modern navigation method. It is based on magnetic spots on the floor that the vehicle senses and follows. The advantages of magnetic spots are easy start-up of projects and good update possibilities. We recommend using this method if laser navigation cannot be used or in combination with it in some special cases.

Wire Navigation

is the most frequently used navigation technology. It has been replaced with navigation via laser and magnetic spots but is still widely used in older systems. Here navigation is based on following a buried electrical wire in the floor. The wire is time-consuming to install and update. Wire navigation is suitable for warehouses and storages with long corridors.

Combination

In some special cases, it is possible to use combination navigation, such as laser navigation together with magnetic spots or wire. This kind of navigation is feasible in some automated warehouses with load-on-load operations, deep stacking, or high racks. Combination navigation has the functionality and advantages of both systems without the limitations of either.

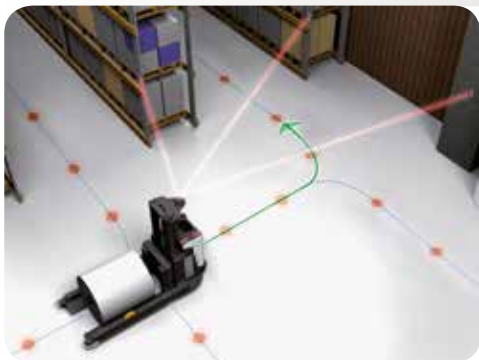
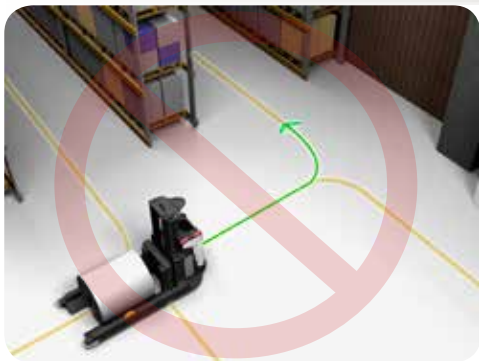

Rocla AGVs are electric driverless trucks. The energy is stored in batteries to ensure long and uninterrupted performance of the system.

There is wide variety in the battery technologies as well as charging methods. The combination of the two varies with the application, environment, number of shifts in operation, load weights, etc. The best combination is selected to ensure the top performance of the system and a good price/quality ratio.

How to store the energy

The most common battery types are:

- » Open lead-acid battery best price/performance ratio, most common
- » Maintenance-free battery the least maintenance
- » Quick-charge battery fast charging

How to ensure the availability of energy

The charging methods are:

- » Manual charging The most economical, with manual connection of cables and charging
- » Opportunity charging = automatic charging Automatic charging when batteries are low or when there is free-time
- » Manual battery exchange Manual changing of batteries with a central battery charging area
- » Automatic exchange Automatic battery exchange with a central battery charging area

The main characteristics of the Rocla automated battery exchange system

- » Ideal for larger AGV systems
- » Decreases the number of vehicles
- » Increases the operating time of the system
- » Provides optimal charging of batteries
- » Central battery filling
- » Extends the life of batteries
- » Serves all vehicles in the Rocla AWT family
- » Takes only a few minutes to change the battery

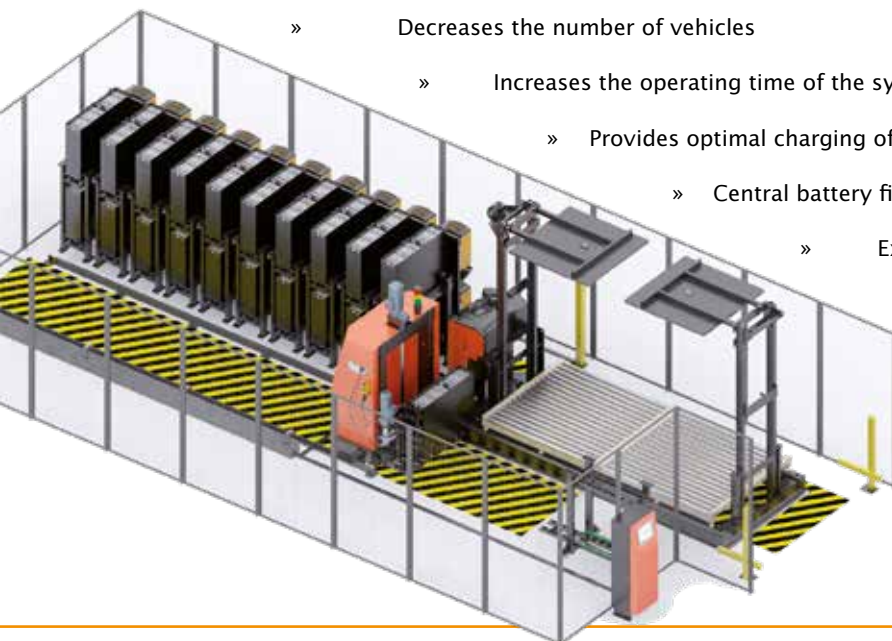

Our goal is to provide our customers with lifetime service support tailored to their specific operation locations and needs. Therefore, we developed a whole range of services to support our customers from the first minute of operation to complete overhauls after decades of work.

Rocla's extensive experience facilitates the design of service agreements that suit customers' specific needs. This ensures the most cost-effective maintenance plan and maximum running time for our customers' AGV systems – vital objectives for achieving maximum profitability – and enables our customers to concentrate on their core competencies.

› **Planned maintenance - key points**

- » Scheduled on-site condition checks 2-6 times per year
- » Maintenance performed partially on the basis of checks' results and partly scheduled
- » Prevention of down-time caused by predictable failures (decreases of 60 to 80 %)
- » Cost savings:
 - » Less unplanned maintenance
 - » Prevention of greater damage
 - » More system up-time

› **Installation audit to maintain safety and performance over decades**

- » Safety inspection (to AGV EN standards)
 - » Avoidance of capacity bottlenecks
 - » Assessment and elimination of disturbances in operation
 - » Addressing of weak spots and high maintenance needs
 - » Reports with recommendations, covering the potential of new solutions and benefits vs. costs

› **24/7 Professional Help Desk**

With their comprehensive product knowledge, our service engineers have a well-earned reputation in the field of AGV maintenance for fast troubleshooting and efficient repairs. Once the customer contacts Rocla's help desk, our system engineers are ready to solve the problem over a remote connection to the customer's system. If the problem cannot be fixed remotely, we send an experienced engineer to the site as soon as possible. All customer information is logged, so it can be accessed easily at any time.



Planned maintenance

Breakdown
repair

Training

Installation
audit

SERVICE

Help desk
24/7

Modifications
& upgrades

Spare parts
Component
overhaul

Retrofits

- » **We are reliable and professional, with decades of experience**
- » **Our engineers are available 24/7**
- » **We are always local, thanks to our extensive service network**
- » **All of our projects are followed by a lifetime service database**

CONTACTS



MidAtlantic.US/AGV